



User Manual







Spring series LFP Battery

SE-G5.1 Pro



Read and follow these instructions!

The following precautions are intended to ensure your safety and prevent property damage. Before installing this product, be sure to read all safety instructions in this document for proper installation.

	<p>⚠ DANGER</p> <p>Failure to comply with the instructions with this symbol may result in a serious accident, causing death or a severe injury.</p>
	<p>⚠ WARNING</p> <p>Failure to comply with the instructions with this symbol may result in a serious accident, causing a severe injury.</p>
	<p>⚠ CAUTION</p> <p>Failure to comply with the instructions with this symbol may result in minor or moderate injury.</p>
	<p>NOTICE</p> <p>Provides information considered important but not hazard-related. The information relates to property damage.</p>
	<p>Read instruction before use</p>
	<p>Risk of electric shock</p>
	<p>Operate as specified by the manual</p>

This product is designed to an integrated system, which must be performed by a qualified person trained in electrical engineering and familiar with the characteristics and safety requirements of lithium batteries. Do not use this product if you are unsure if you possess the necessary skills to complete this integration.

Table of Contents

1. Precautions	3
1.1 General Safety Precautions	3
1.2 Installation Precautions	3
2. Product Introduction	4
2.1. Front Panel Function Introduction	4
2.2 Product Specifications	6
2.3 State Indicator	6
3. Unpack the Battery.....	7
3.1 Parts List.....	7
3.2 Visual Inspection of the Modules	8
4. Battery Installation.....	9
4.1 Battery Module Installation.....	10
5. Cable Connection.....	11
5.1 Single Battery Connection	11
5.2 Connect Cables of the Multiple Batteries in Parallel.....	15
5.3 Visual Inspection of the Connection	18
6. Activate the Product	18
6.1 Start the Battery.....	18
7. Inspection, Cleaning and Maintenance.....	18
7.1 General Information	18
7.2 Inspection	19
7.3 Cleaning	19
7.4 Maintenance	19
7.5 Storage.....	19
8. Troubleshooting	19
9. Firmware Update.....	20
9.1 USB Upgrade.....	20
9.2 PC Upgrade	21
9.3 PCS Upgrade	24
10. Battery recovery	25
10.1 Recovery process and steps of cathode materials	25
10.2 Recovery of anode materials	26
10.3 Recovery of diaphragm.....	26
10.4 List of recycling equipment:.....	26
11. Transportation Requirements	26

1. Precautions

1.1 General Safety Precautions

The product provides a safe source of electrical energy when operated as intended and as designed. Potentially hazardous circumstances such as excessive heat or electrolyte mist may occur under improper operating conditions, damage, misuse and/or abuse. The following safety precautions and the warning messages described in this part must be observed.

If any of the following precautions are not fully understood, or if you have any questions, contact us for guidance.

Risks of explosion

- Do not subject the battery to strong impacts.
- Do not crush or puncture the battery.
- Do not dispose of the battery in a fire.

Risks of fire

- Do not expose the battery to temperatures in excess of 60°C.
- Do not place the battery near a heat source such as a fireplace.
- Do not expose the battery to direct sunlight.
- Do not allow the battery connectors to touch conductive objects such as wires.

Risks of electric shock

- Do not disassemble the battery.
- Do not touch the battery with wet hands.
- Do not expose the battery to moisture or liquids.
- Keep the battery away from children and animals.

Risks of damage to the battery

- Do not allow the battery to encounter liquids.
- Do not subject the battery to high pressures.

1.2 Installation Precautions

Please be aware that a battery presents a risk of electrical shock including high short-circuit current. Follow all safety precautions while operating the batteries.

- Remove watches, rings, and other metallic accessories.
- Use tools with insulated handles in order to avoid inadvertent short circuits.
- Wear rubber gloves and safety boots.
- Do not put tools or any metal parts on the top of the batteries.
- Disconnect charging source and load before connecting or disconnecting terminals.
- When moving batteries and wear all appropriate safety clothing and equipment.

- Do not open or mutilate the batteries.

	⚠ CAUTION
	<ul style="list-style-type: none">▪ Verify polarity at all connections before energizing the system. Reverse polarity at the battery terminals will void the Warranty and destroy the batteries. Do not short circuit the batteries.▪ Do not combine Lithium Batteries with other brands or chemistries; Do not mix Lithium Batteries from different installations, clients, or job sites.▪ Do not disassemble or modify the battery. If the battery housing is damaged, do not touch exposed contents.

2. Product Introduction

51.2 V series lithium iron phosphate battery system has been designed to provide power backup for remote or outside telecom plants like Access Terminals, Base Transceiver Stations, and Base Station Controllers. This system has the characteristics of high system integration, well reliability, long service life, and wide operating temperature range.

2.1. Front Panel Function Introduction

In order to operate the product correctly, please carefully view the function of the front panel of the battery.

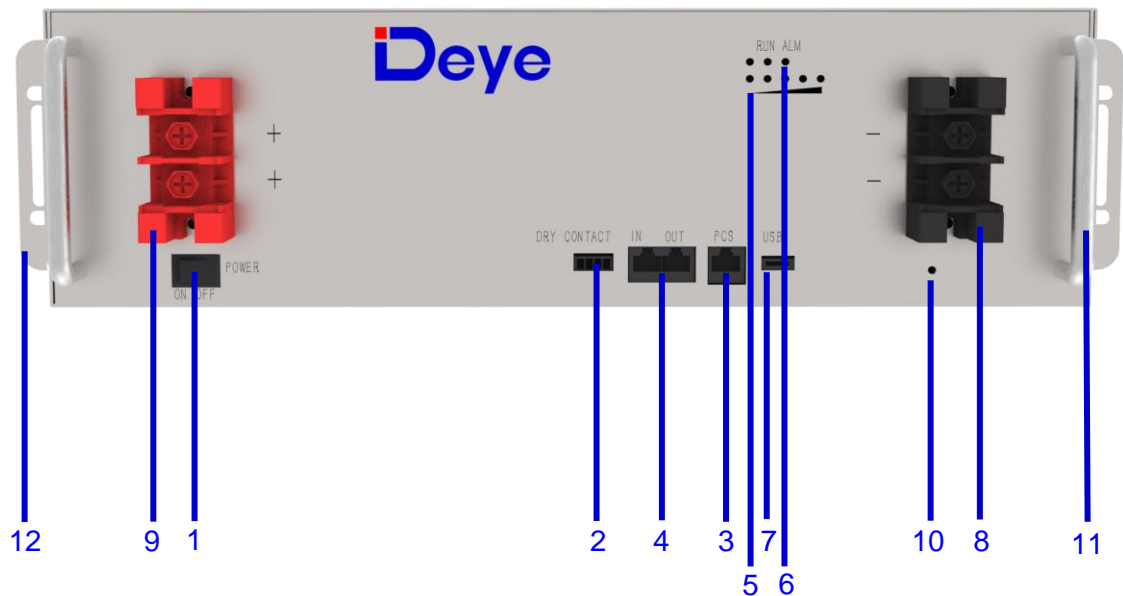

Figure 2-1: Front Panel Function Introduction

1. Power button: to turn ON/OFF the whole battery BMS standby, no power output.
2. DRY CONTACT output.
3. PCS: Inverter communication terminal: (RJ45 port) follow the CAN protocol (baud rate: 500kbps), and RS-485 (baud rate: 9600bps), used to output battery information to the inverter.
4. IN: parallel Communication Terminal: (RJ45 port) Connect "out" Terminal of Previous battery, for communication between multiple parallel batteries.
 OUT: parallel Communication Terminal: (RJ45 port) Connect "IN" Terminal of Next battery, for communication between multiple parallel batteries.
5. SOC: These 5 LEDs are used to display the pack SOC. The lightning of these LEDs indicates the SOC of 20%, 40%, 60%, 80% and 100%.
6. RUN light: green LED lighting to show the battery running status
 Alarm light: yellow and red LED lighting to show the battery has been alarmed or protected.
7. USB: (USB port) Used to insert USB flash drive for battery upgrade.
8. Negative output terminal.
9. Positive output terminal.
10. Grounding bolt.
11. Handle: It was used to carry/move the battery.
12. Used for fixing with cabinet.

2.2 Product Specifications

Table 2-1: Product Specifications

Main Parameter		SE-G5.1 Pro
Battery Chemistry		LiFePO4
Capacity (Ah)		100
Scalability		Max. 64 pcs pack (327kWh) in parallel (Max. 32 pcs no external setup)
Nominal Voltage (V)		51.2
Operating Voltage(V)		43.2~57.6
Energy (kWh)		5.12
Usable Energy (kWh) ^[1]		4.61
Charge/Discharge Current (A)	Recommend ^[2]	50
	Max. ^[2]	100
	Peak(2mins,25°C)	150
Other Parameter		
Recommend Depth of Discharge		90%
Dimension (W/H/D, mm)		445*133*430
Weight Approximate(kg)		44
Master LED indicator		5LED(SOC:20%~100%)
		3LED (working, alarming, protecting)
IP Rating of enclosure		IP20
Working Temperature		Charge:0°C~55°C Discharge:-20°C~55°C
Storage Temperature		0°C~35°C
Humidity		5%~95%
Altitude		≤2000m
Cycle Life		≥6000(25±2°C,0.5C/0.5C,70%EOL)
Installation		19-inch standard cabinet, cabinet depth ≥600mm / with rack
Communication Port		CAN2.0, RS485
Certification		UL1973, IEC62619, CE, UN38.3

[1] DC Usable Energy, test conditions: 90% DOD, 0.5C charge & discharge at 25°C. System usable energy may vary due to system configuration parameters.



[2] The current is affected by temperature and SOC.

2.3 State Indicator

Condition	RUN	ALM	ERROR	SOC1	SOC2	SOC3	SOC4	SOC5	
Power Off	Off								
Discharge or Idle	Blink	Blink if Alarm Exists	Off	e.g., Soc67%:					
			Off	Off	On	On	On	On	
Charge		Blink	Blink	Off	e.g., Soc47%:				
				Off	Off	Off	Blink	On	On
Alarm	Blink	Blink	Off	Same as 'Discharge or Idle'					
System Error/Protection			On						
Upgrade	Blink Fastly								
Critical Error	Blink Slowly								

3. Unpack the Battery

The battery and the related accessories are packed in the carton box. Use tools to open the packing box. After open the packing box, confirm the product components according to the parts list.

	
	<p>Violent unpacking is strictly prohibited. If the battery system is found to be broken, deformed or other abnormal conditions, the user shall immediately stop using the battery and contact us.</p>

3.1 Parts List

Check the parts during unpacking.

Table 3-1: Parts Lists











No.	Items	Appearance	Usage	Qty.	Remarks
1	Battery		Provide power	1	
2	RJ45 communication line 300mm		Communication cable for battery parallel	1	
3	4AWG Red & Black Power line 300mm		Power cable for battery parallel	2	
4	10AWG yellow-green ground line 300mm		Battery ground line	1	
5	M6*16 Cabinet bolt		Fix the battery on the rack or cabinet	4	
6	Battery Rack Fixed Ears and M4*8 bolt		Used for battery fixing with 19inch rack or cabinet	2 ears 6 bolts	
7	User manual	/	/	1	

Table 3-2: Recommended Tools and Instruments

No.	Items	Usage	Appearance
1	Phillips Screwdriver or Bit	To fasten battery and assemblies	
2	Box Cutter	Opening boxes	
3	Insulated Torque Wrench	Installing cables and busbars	
4	Insulated Sockets	Installing cables and busbars	
5	Battery Tester	Measure battery module's voltage	

3.2 Visual Inspection of the Modules

After transporting the modules to the installation location, check for:

- Physical damage to the exterior
- Damaged or protruding screws

4. Battery Installation

This system must be installed by qualified, trained workers familiar with the required instruments.

	⚠ WARNING
	<ul style="list-style-type: none">▪ Be sure to use insulated tools (torque wrench, extension, socket, etc.).▪ All the instruments must be insulated and no metal articles (e.g., watch, ring) should be present in the installation area.▪ All power switches must be turned off in advance.▪ Prepare a CO₂ fire extinguisher, a first aid kit, and an AED (automated external defibrillator) before installation.

	⚠ WARNING
	Arc Flash and Shock Hazard Insulated tools are required for any work on this energized equipment.

	⚠ WARNING
	Sharp Edges Wear gloves and other protective gear to prevent injury.

	⚠ WARNING
	Pinch Point Use caution when working in the enclosure to prevent injury.

	⚠ CAUTION
	Heavy Object Can cause muscle strain or back injury. Use lifting aids and proper lifting techniques when moving trays, batteries and other heavy objects.

4.1 Battery Module Installation

1. Transport battery modules to the installation location.
2. Place the battery modules on the bracket or rack or cabinet.
3. Fix the battery on the bracket or rack. Using the bracket or cabinet bolt to fix the battery into the bracket or rack.
4. After installation, tighten all bolts.

Installation method 1: With simple bracket installation

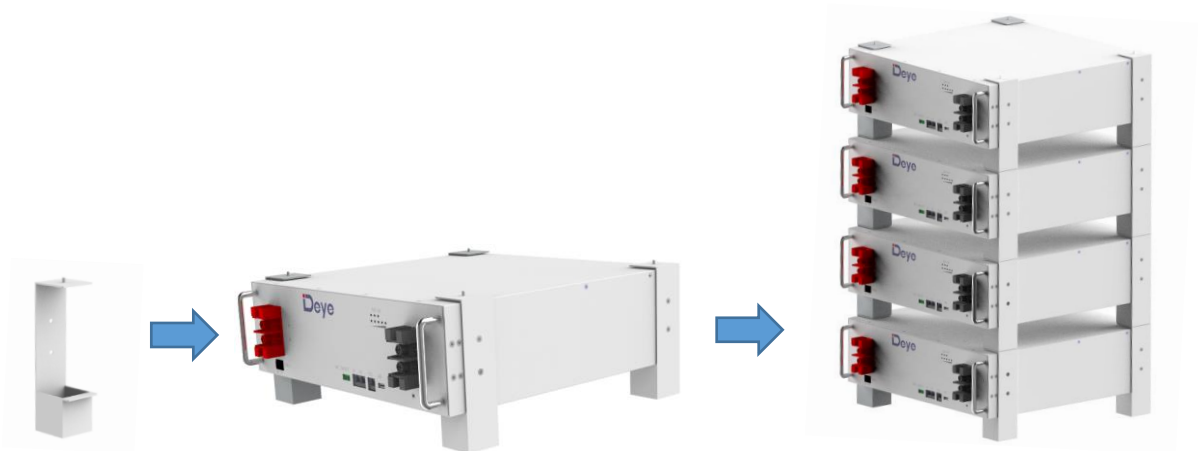

Installation method 2: With standard 19 inches cabinet or rack installation



	IMPORTANT
	<ul style="list-style-type: none"> ▪ The battery can be mounted on a standard 19 inches cabinet or rack. ▪ Battery modules can be inserted into a rack frame according to the customer battery configuration scheme.

Other Installation method: If there is no cabinet and simple bracket.



Note the allowable installation modes.



5. Cable Connection

5.1 Single Battery Connection

	NOTICE
	<ul style="list-style-type: none"> ▪ Before connect the cable with the inverter, the worker must confirm the output switch of the inverter has been turn off, to prevent the risk of fire or electric shock.

	<p>CAUTION</p> <ul style="list-style-type: none"> ▪ Before connection, make sure to close the battery. ▪ Please follow the instructions to protect the module BMS against damage. ▪ DO NOT deviate from the sequence of steps below. ▪ Exercise extreme caution prevent the terminals from contacting anything except their intended mounting points. ▪ Terminals and their connected wires have either positive or negative polarity (Positive: +; Negative-). The polarity of a terminal or a wire connected to the terminal is on the front of each module. Exercise extreme caution to prevent the terminals and/or wires with opposite polarity from contacting with each other. ▪ The maximum voltage of the battery is no more than 60V, which is higher than the safe voltage of 36V. Therefore, we still recommend that the battery terminals or other exposed parts should not be directly touched during the
	<p>NOTICE</p> <ul style="list-style-type: none"> ▪ When tightening the screws, make sure they are at a straight angle from the battery module terminals to avoid damage to the nuts inside. ▪ Assemble the screws using a Phillips-head within the fastening torque of less than 8.0 Nm (81.5 kgf•cm).
	<p>IMPORTANT</p> <ul style="list-style-type: none"> ▪ The power terminals, such as “+,” “-,” of the module are covered with the protecting cover to guard against a short circuit (Shown in Figure 5-1). ▪ You must remove the insulation cover prior to connecting and reattach the insulation cover immediately after connecting.

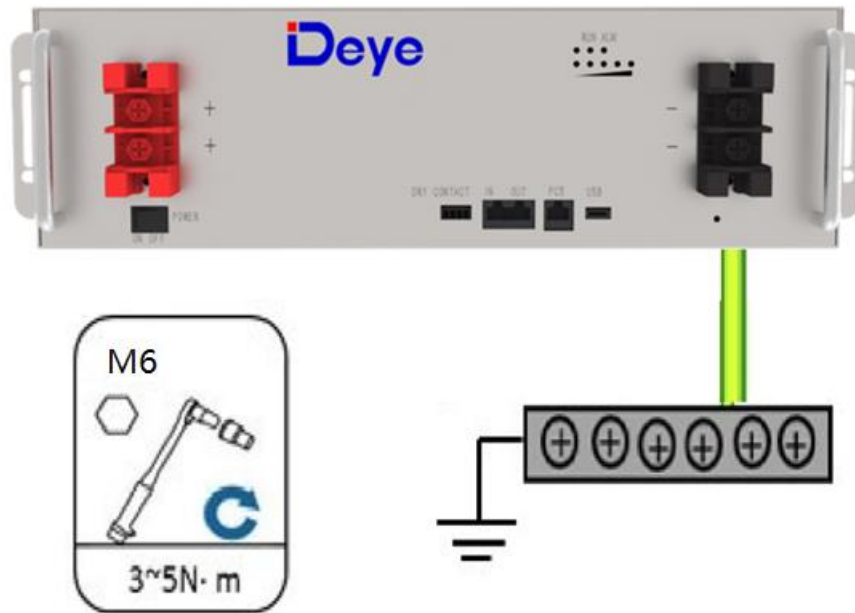

Figure 5-1: Install the Grounding Wire

Step 1 Wear the protective gloves.

Step 2 Install the battery ground cable.

Step 3 Install negative and positive power cables for the battery.

- 1) Remove the protective cover from the battery power wiring terminal.
- 2) Connect the negative power cable to the battery.
- 3) Connect the positive power cable to the battery.
- 4) Install the other end of the battery power cables at a battery route and the corresponding busbar in the power system.
- 5) Reinstall the protective cover on the battery power wiring terminals.

Connect the inverter:

- 1) Remove the protecting cover.
- 2) Take-down positive fixing bolt by the Phillips Screwdriver and connect the positive output cable between the battery positive terminal of the battery and the inverter. After connecting the battery, fastening bolt immediately to avoid dropping.

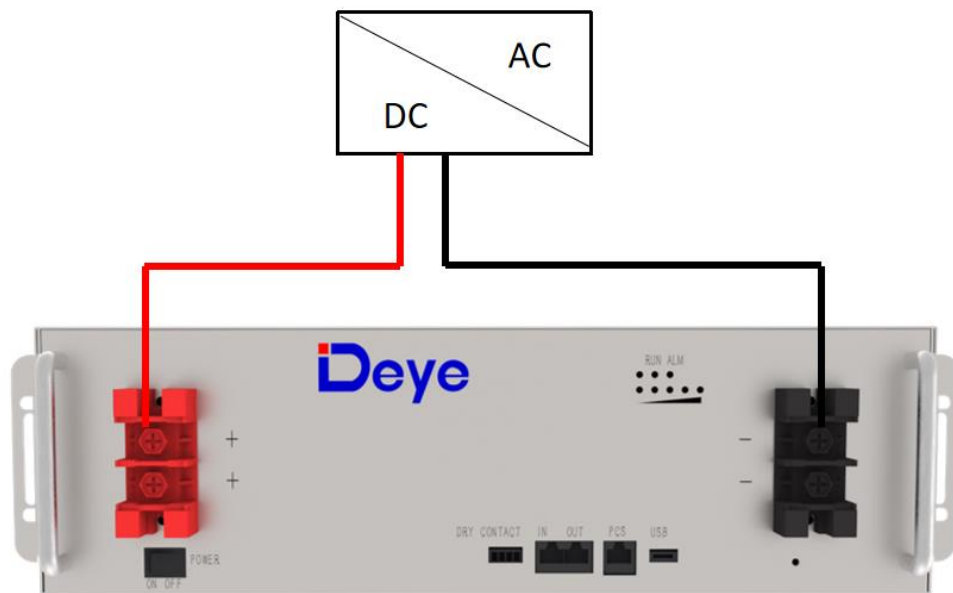

Figure 5-2: Single Battery Connection

- 3) Take-down negative fixing bolt by the Phillips Screwdriver and connect the negative output cable between the battery negative terminal of the battery and the inverter. After connecting the battery, fastening bolt immediately to avoid dropping.
- 4) Install the protecting cover.
- 5) Sort the cables and fasten the battery cables to the perforated bracket with cable ties.
- 6) Communication Line Connection

As shown in Figure 5-3, when monitoring the battery by the computer, connect the 'USB convert CAN Box communication line between battery and computer.

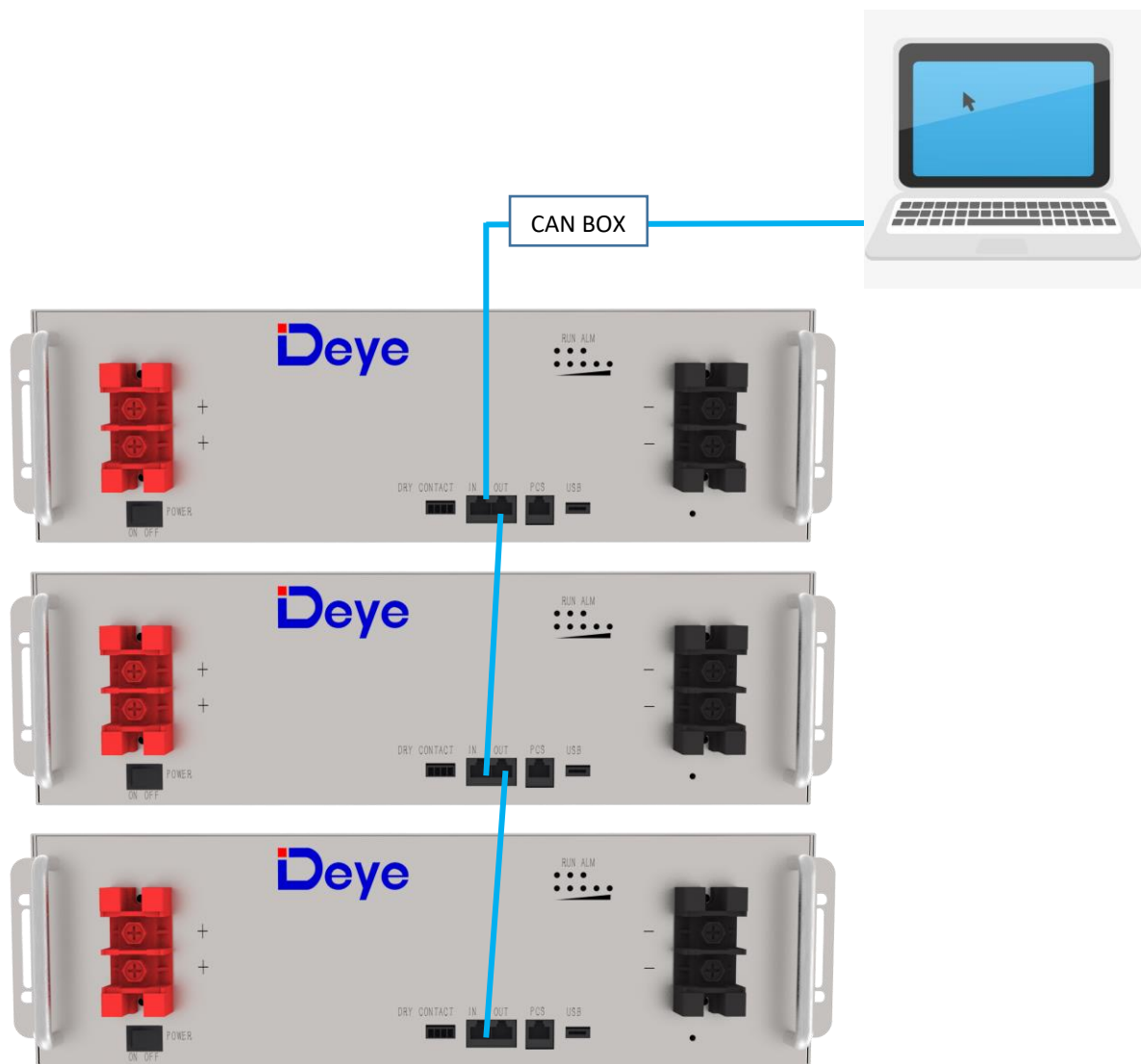

Figure 5-3: Communication Cable Connections between Battery and Computer

5.2 Connect Cables of the Multiple Batteries in Parallel

When multiple batteries in parallel, the cable connecting procedures are follows.

5.2.1. As shown in Figure 5-4, following the cable connection method of the single battery, connect the positive and negative cables between the Battery 1 and the busbar, Battery 2 and the busbar, and Battery N and the busbar respectively.

Note: To ensure the current balance, please use cables with the same diameter and length for each battery.

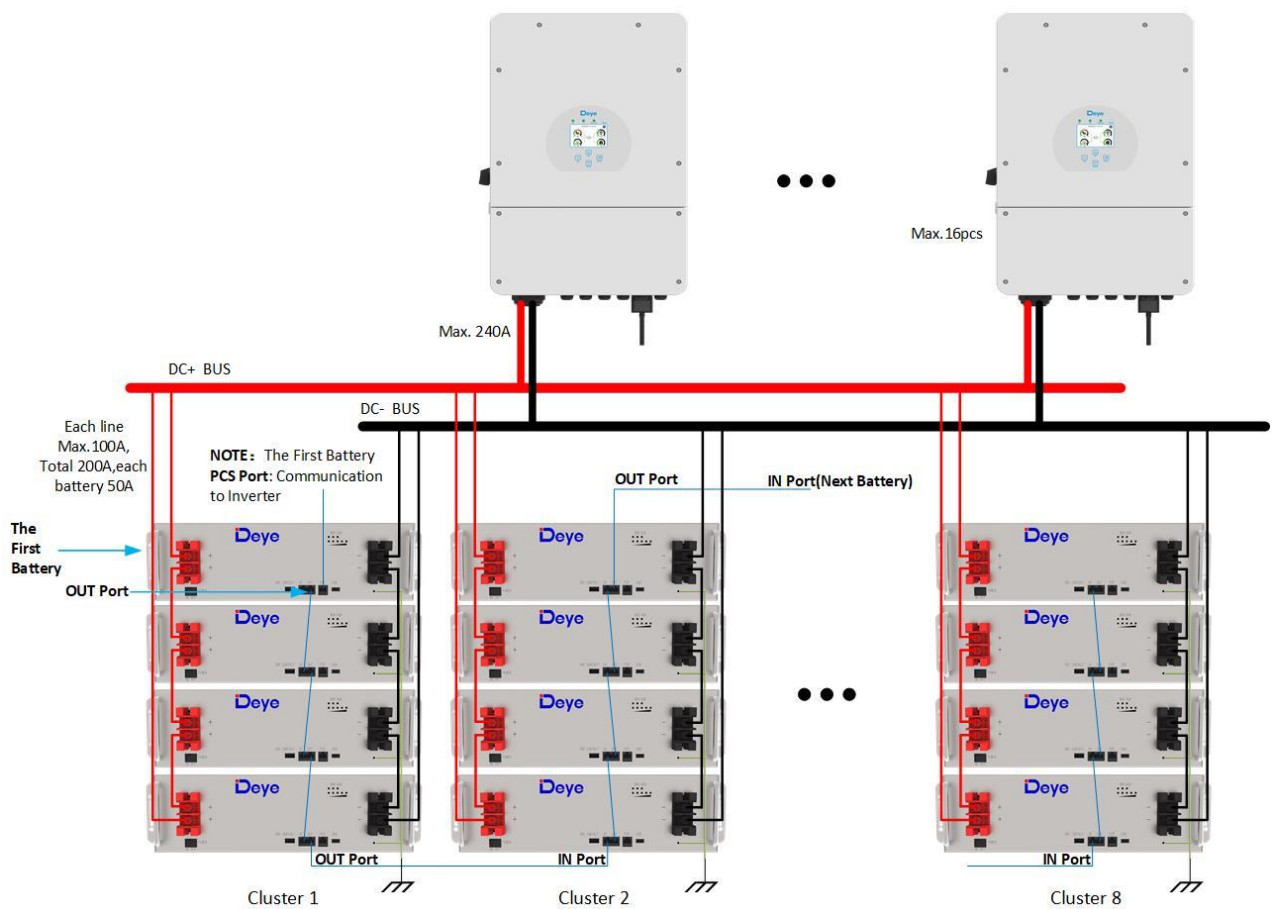

Figure 5-4: Multiple Batteries Connections

5.2.2. As shown in Figure 5-4, connect the communication line (a standard RJ45 network cable) between the adjacent batteries.

Note: The **PCS Port** of the first battery must be connected to the inverter's battery communication interface, otherwise the inverter cannot communicate with the batteries.

Note: The **OUT Port** of the first battery is connected to the **IN Port** of the next battery, and so on, connecting the communication of multiple batteries together, otherwise multiple batteries will not be able to communicate correctly.

5.2.3. Connect the communication line between battery and inverter

(1) PCS Port Definition

Definition of PCS Port Pin

No.	PCS Port Pin
1	485-B
2	485-A
3	—
4	CANH
5	CANL
6	—
7	485-A
8	485-B



(2) IN Port Definition

Definition of IN Port Pin

No.	PCS Port Pin
1	CANL
2	CANH
3	DI+
4	DI-
5	DI-
6	DI+
7	CANH
8	CANL



(3) OUT Port Definition

Definition of Out Port Pin

No.	Out Port Pin
1	CANL
2	CANH
3	DO+
4	DO-
5	DO-
6	DO+
7	CANH
8	CANL



5.3 Visual Inspection of the Connection

After connecting the battery, check for:

- Usage of positive and negative cables.
- Connection of the positive and negative terminals.
- All the bolts are tightened.
- Cables fixation and the appearance.
- The communication cable is connected correctly.
- The installation of the protecting cover.

6. Activate the Product

6.1 Start the Battery

After installation, wiring, and configuration are completed, you must check all the connection. When the connections are correctly, and then press power button to activate the battery. The green working light on the front panel of the battery flashes, indicating that the battery system is normal.

7. Inspection, Cleaning and Maintenance

7.1 General Information

- The battery product is not fully charged. It is recommended that the installation be completed within 3 months after arrival;
- During the maintenance process, do not re-install the battery in the battery product. Otherwise, the performance of the battery will be reduced;
- It is forbidden to dismantle any battery in the battery product, and it is forbidden to dissect the battery;
- After the battery product is over-discharged, it is recommended to charge the battery within 48 hours. The battery product can also be charged in parallel. After the battery product is connected in parallel, the charger only needs to connect the output port of any product battery.
- Never attempt to open or dismantle the battery! The inside of the battery does not contain serviceable parts.
- Disconnect the Li-Ion battery from all loads and charging devices before performing cleaning and maintenance activities
- Place the enclosed protective caps over the terminals before cleaning and maintenance activities to avoid the risk of contacting the terminals.

7.2 Inspection

- Inspect for loose and/or damaged wiring and contacts, cracks, deformations, leakage, or damage of any other kind. If damage to the battery is found, it must be replaced. Do not attempt to charge or use a damaged battery. Do not touch the liquid from a ruptured battery.
- Regularly check the battery's state of charge. Lithium Iron Phosphate batteries will slowly self-discharge when not in use or whilst in storage.
- Consider replacing the battery with a new one if you note either of the following conditions:
 - The battery run time drops below 70% of the original run time.
 - The battery charge time increases significantly.

7.3 Cleaning

If necessary, clean the Li-Ion battery with a soft, dry cloth. Never use liquids, solvents, or abrasives to clean the Li-Ion battery.

7.4 Maintenance

The Li-Ion battery is maintenance free. Charge the battery to approximately > 80% of its capacity at least once every year to preserve the battery's capacity.

7.5 Storage

- The battery product should be stored in a dry, cool, and cool environment;
- Generally, the maximum storage period at room temperature is 6 months. When the battery is stored over 6 months, it is recommended to check the battery voltage. If the voltage is higher than 51.2V, it can continue to store the battery. In addition, it is needed to check the voltage at least once a month until the voltage is lower than 51.2V. When the voltage of the battery is lower than 51.2V, it must to be charged according to the charging strategy.
- The charging strategy is as follows: discharge the battery to the cutoff voltage with 0.2C₁₀A current, and then charge with 0.2C₁₀A current for about 3 hours. Keep the SOC of the battery at 40-70% when stored;
- When the battery product is stored, the source of ignition or high temperature should be avoided and it should be kept away from explosive and flammable areas.

8. Troubleshooting

To determine the status of the battery system, users must use additional battery status monitoring software to examine the protection mode. Refer to the installation manual about using the monitoring software. Once the user knows the protection mode, refer to the following sections for solutions.

Table 8-1: Troubleshooting

Fault Type	Fault Generation condition	Possible Causes	Troubleshooting
BMS fault	The cell voltage sampling circuit is faulty. The cell temperature sampling circuit is faulty	The welding point for cell voltage sampling is loose or disconnected. The voltage sampling terminal is disconnected. The fuse in the voltage sampling circuit is blown. The cell temperature sensor has failed.	Replace the battery.
Electrochemical cell fault	The voltage of the cell is low or unbalanced.	Due to large self- discharge, the cell over discharges to below 2.0V after long term storage. The cell is damaged by external factors, and short circuits, pinpricks, or crushing occur.	Replace the battery.
Overtoltage protection	The cell voltage is greater than 3.65 V in charging state. The battery voltage is greater than 58.4 V.	The busbar input voltage exceeds the normal value. Cells are not consistent. The capacity of some cells deteriorates too fast or the internal resistance of some cells is too high.	If the battery cannot be recovered due to protection against abnormality contact local engineers to rectify the fault.
Under voltage protection	The battery voltage is less than 40V. The minimum cell voltage is less than 2.5V	The mains power failure has lasted for a long time. Cells are not consistent. The capacity of some cells deteriorates too fast or the internal resistance of some cells is too high.	Same as above.
Charge or discharge high temperature protection	The maximum cell temperature is greater than 60°C	The battery ambient temperature is too high. There are abnormal heat sources around	Same as above.
Charge low temperature protection	The minimum cell temperature is less than 0°C	The battery ambient temperature is too low.	Same as above.
Discharge low temperature protection	The minimum cell temperature is less than -20°C	The battery ambient temperature is too low.	Same as above.

By checking the above data and sending the data to the service personnel of our company, the service personnel of our company will reply the corresponding solution after receiving the data.

9. Firmware Update

9.1 USB Upgrade

- USB only supports USB flash drives with FAT32 file system format.
- In addition, there is a fixed folder name for storing upgrade files inside the U disk, the upgrade files must be placed in the first level of the directory folder: upgrade inside.
- At the same time, it is suggested that it is best to keep only the bin files that need to be upgraded.

9.2 PC Upgrade

1. Upgrade all the PACKs of the system

Step 1. After successfully connecting to the upper computer, select "Firmware - Browse - Upgrade File"

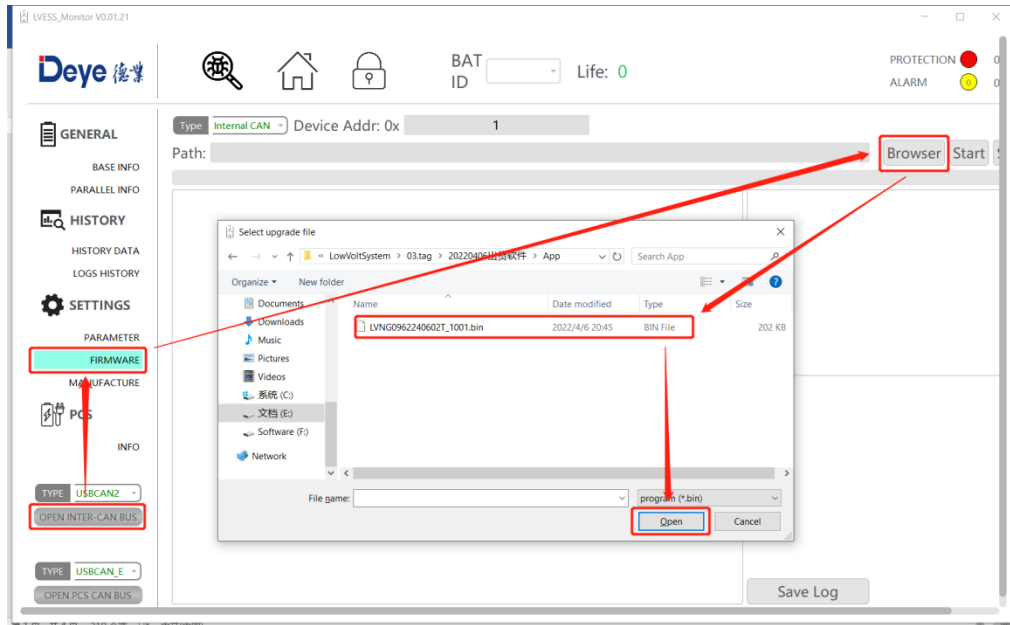

Step 2. Click to start

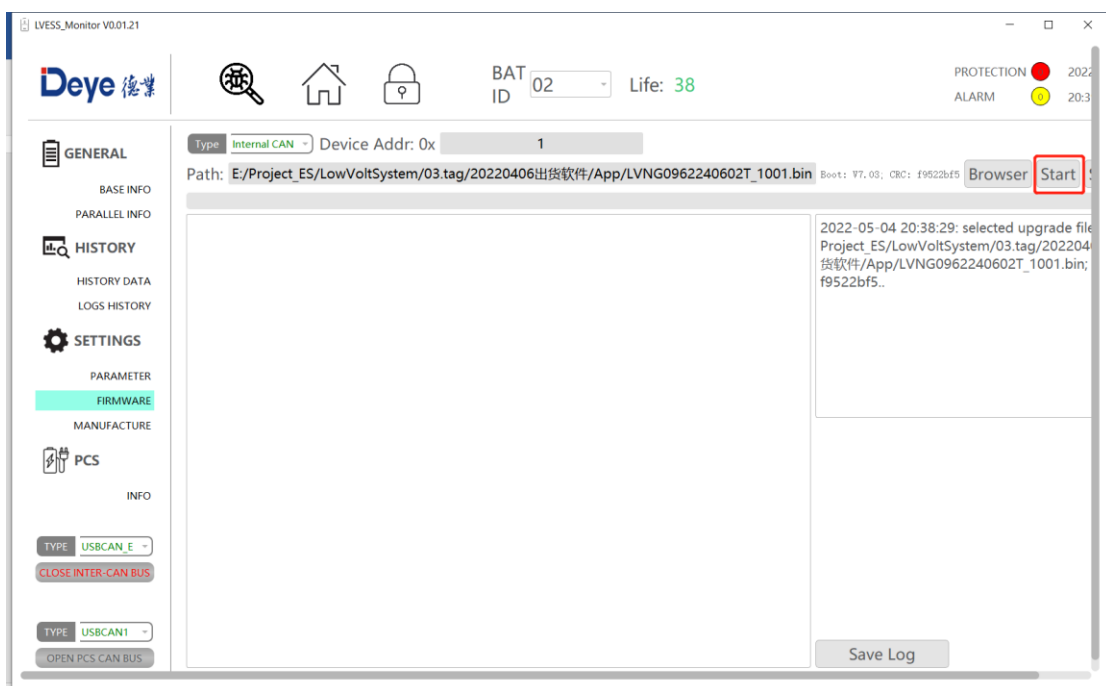

Step 3. If the system upgrade is successful, the lower right corner will prompt green success, and if it fails, it will prompt red failure.

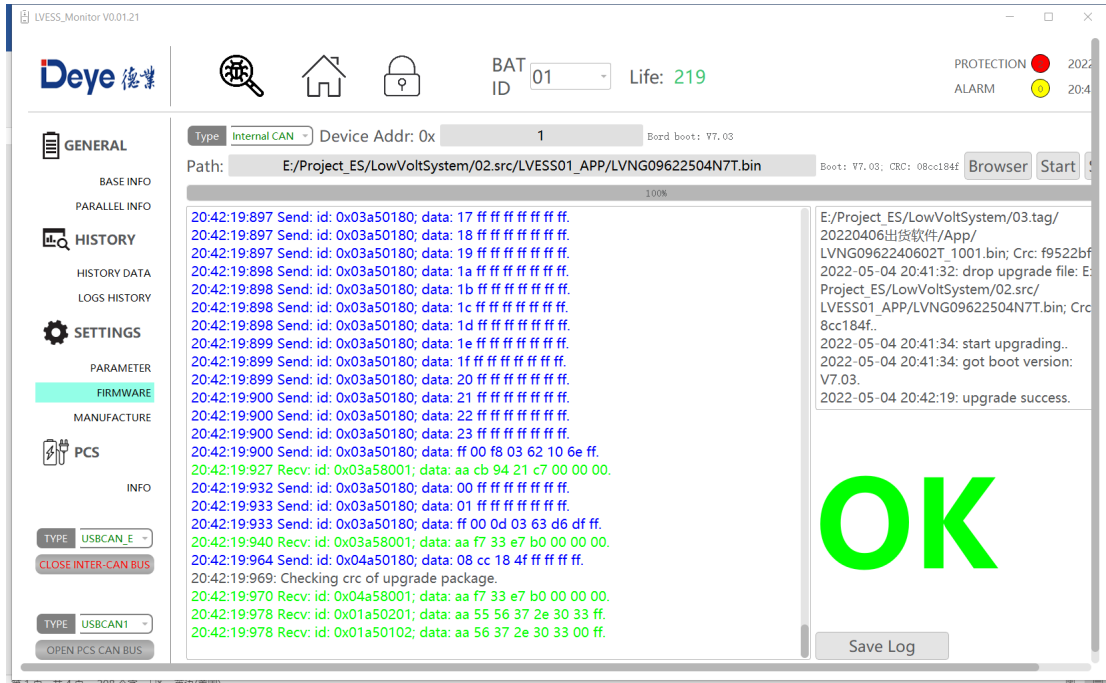

2. Upgrade a single PACK

Step 1. After successfully connecting to the host computer, select "Firmware - Browse - Upgrade File"

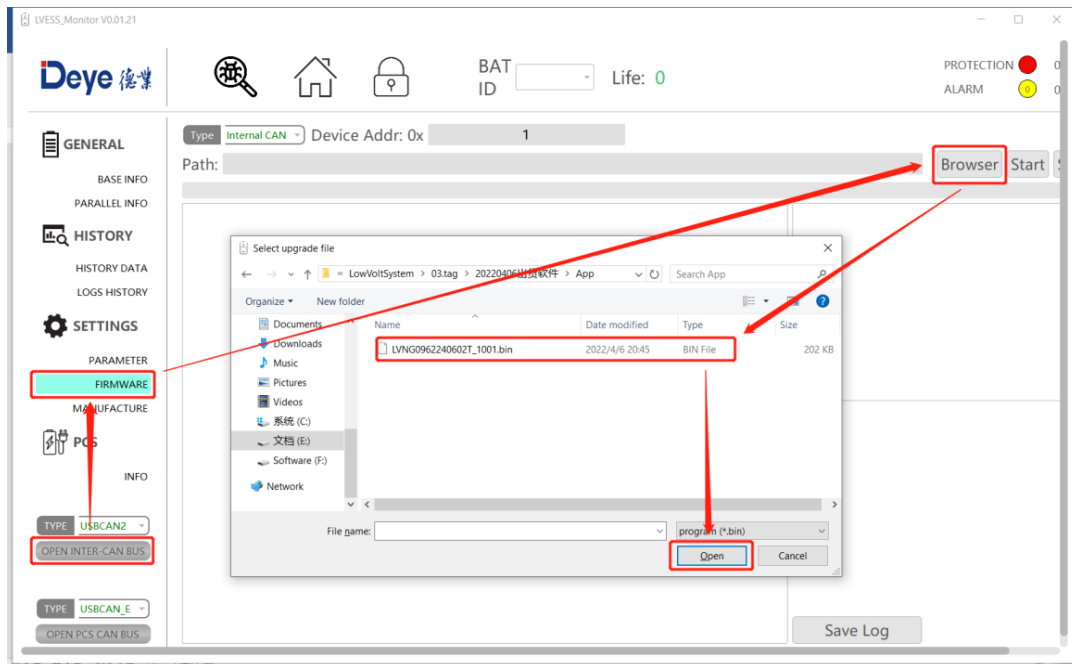

Step 2. Select the upgrade pack number, if there is "0x" in "Device Address", enter the

corresponding hexadecimal number, such as upgrading Pack No. 29, enter 1D; if there is no "0x" in "Device Address", enter the corresponding decimal number No., if you upgrade Pack No. 25, enter 25.

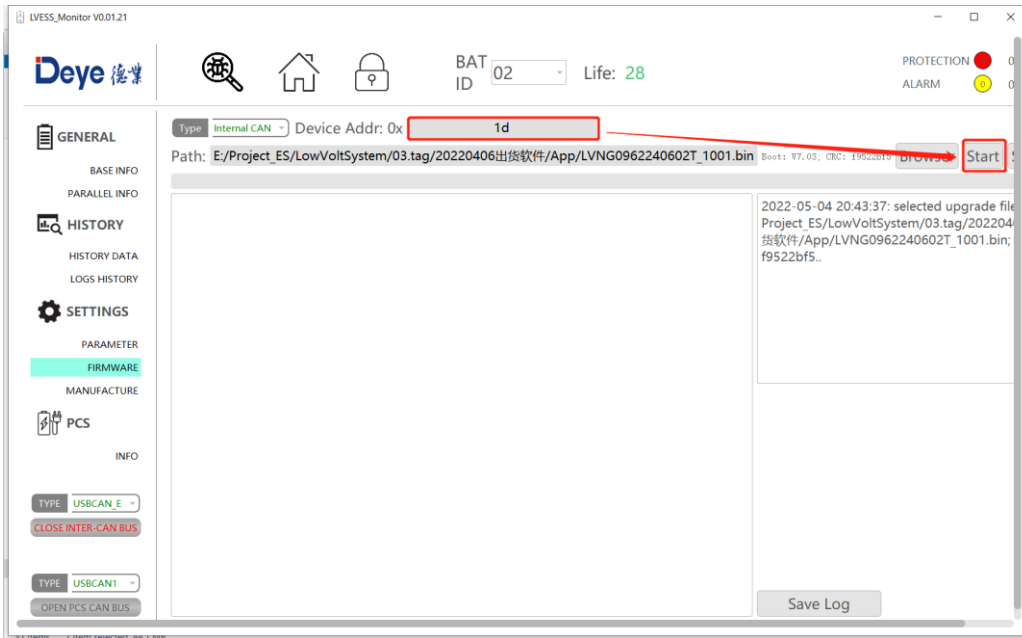

Step 3. If the system upgrade is successful, the lower right corner will prompt green success, and if it fails, it will prompt red NG.

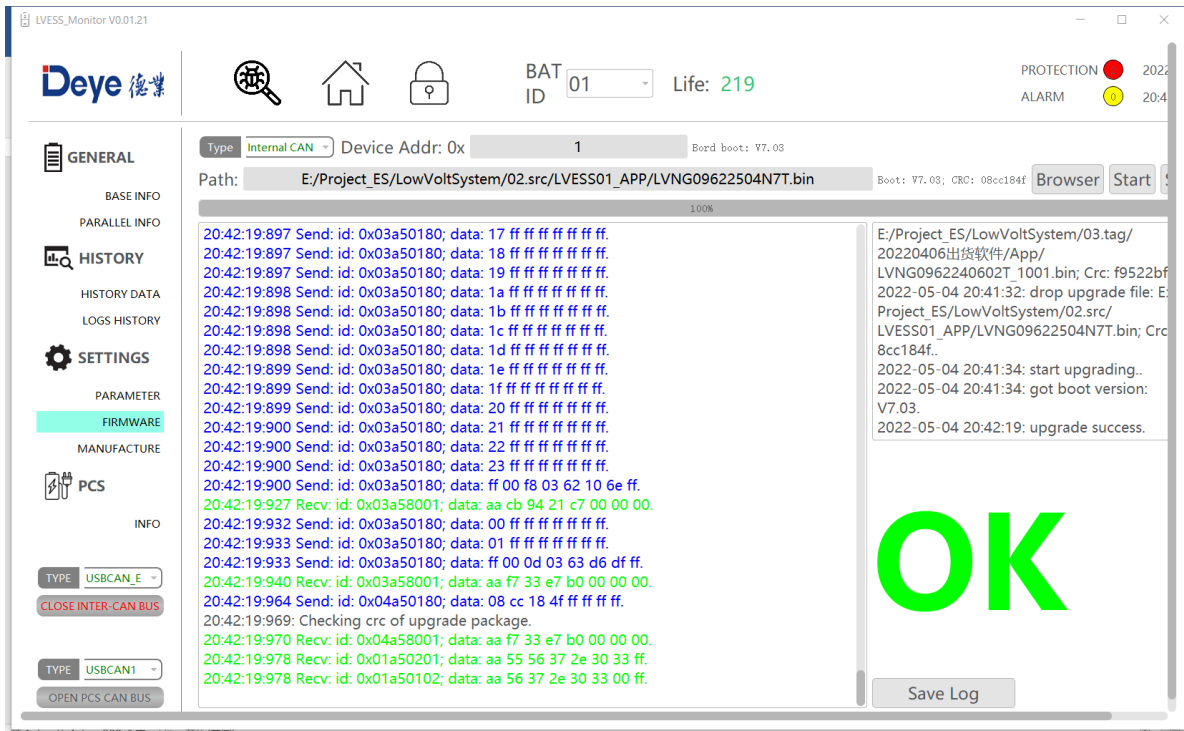

9.3 PCS Upgrade

Step1. Open the website <https://pv.inteless.com/plants>, enter the account number and password

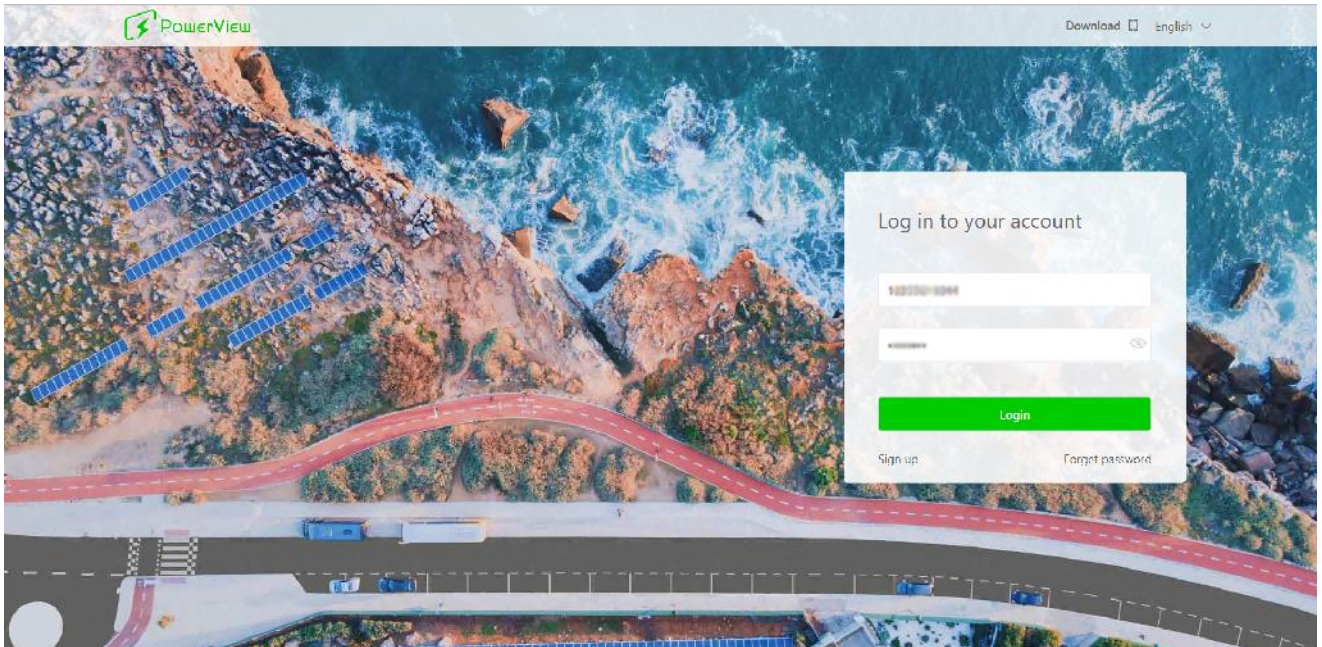

Step2. In the device list-inverter list, enter the collector serial number to find the target collector.

The 'Status Statistics' section shows the following data:

Status	Count
Normal	10556
Warning	24
Fault	13
Offline	10828
All	21421

The 'Device List' table shows the following data:

Status	SN	Device Alias	Power(W)	E-Today(kWh)	Version	Gateway	Plant Name	More
Normal	2112016566	2112016566	5781	0	6.0.0.6	E470121BE705	Stefan Smit	...
Normal	2112146182	2112146182	1802	0	3.3.6.7	E470121BF978	josef	...
Normal	2112086181	2112086181	0	0	3.3.6.7	E470121BF914	Robbie Frank	...
Normal	2201267151	2201267151	0	0	6.0.1.0	E47012214298	Marinda McDon...	...
Normal	2202214325	2202214325	355	0.2	3.3.7.1	E47012216017	Helene van Dyk	...

Step3. Select the target device and click Remote Upgrade.

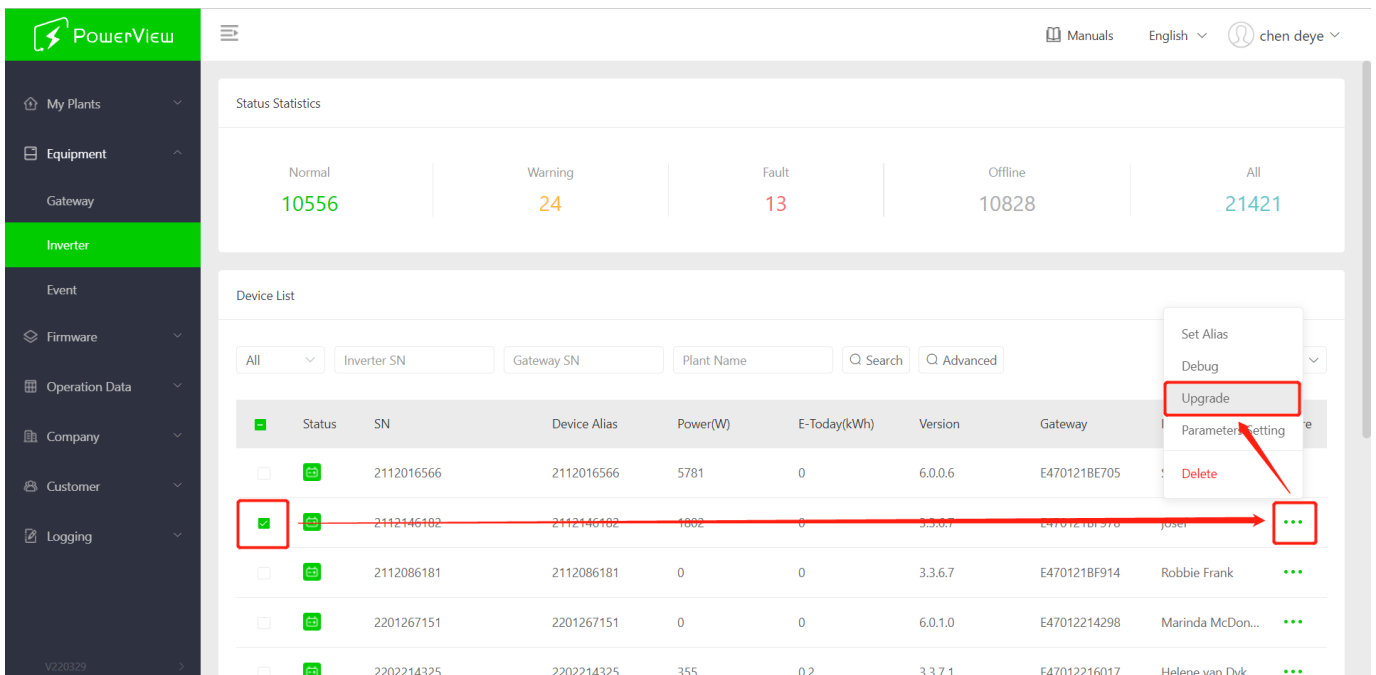

Step4. Select "Energy Storage Machine/BMS" for the firmware type, select the firmware version provided by the technician, and click OK to start the upgrade.

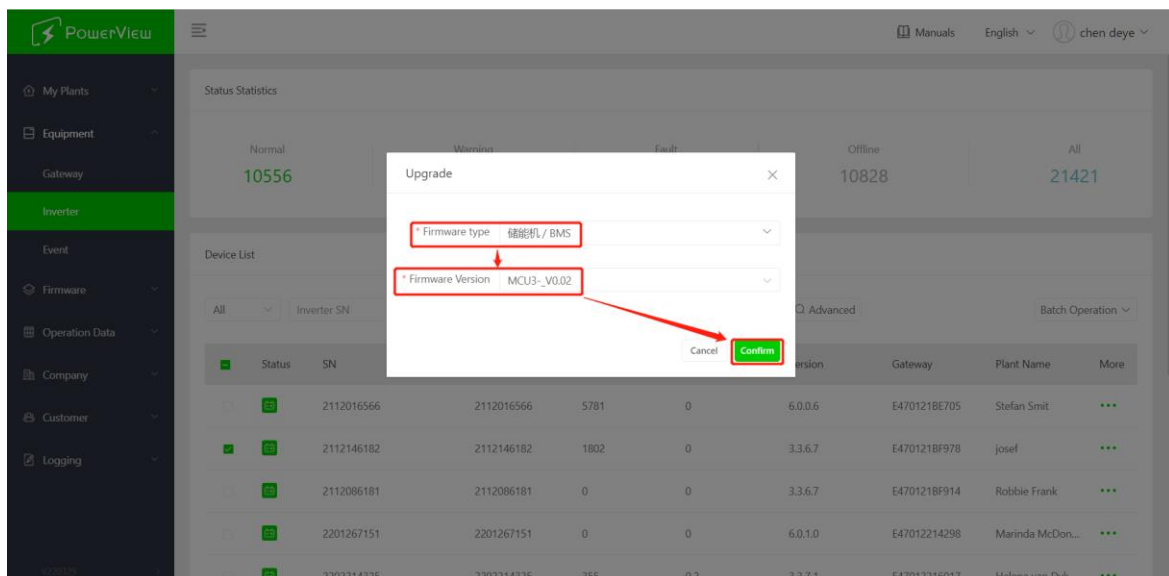

10. Battery recovery

Aluminum, copper, lithium, iron and other metal materials are recovered from discarded LiFePO4 batteries by advanced hydrometallurgical process, and the comprehensive recovery efficiency can reach 80%. The specific process steps are as follows:

10.1 Recovery process and steps of cathode materials

Aluminum foil as collector is amphoteric metal. Firstly, it is dissolved in NaOH alkali solution to

make aluminum enter the solution in the form of NaAlO_2 . After filtration, the filtrate is neutralized with sulfuric acid solution and precipitated to obtain $\text{Al}(\text{OH})_3$. When the pH value is above 9.0, most of the aluminum precipitates, and the obtained $\text{Al}(\text{OH})_3$ can reach the level of chemical purity after analysis.

The filter residue is dissolved with sulfuric acid and hydrogen peroxide, so that lithium iron phosphate enters the solution in the form of $\text{Fe}_2(\text{SO}_4)_3$ and Li_2SO_4 , and is separated from carbon black and carbon coated on the surface of lithium iron phosphate. After filtration and separation, the pH value of the filtrate is adjusted with NaOH and ammonia water. First, iron is precipitated with $\text{Fe}(\text{OH})_3$, and the remaining solution is precipitated with saturated Na_2CO_3 solution at 90°C . Since FePO_4 is slightly dissolved in nitric acid, the filter residue is dissolved with nitric acid and hydrogen peroxide, which directly precipitates FePO_4 , separates impurities such as carbon black from acid solution, leaches $\text{Fe}(\text{OH})_3$ from filter residue respectively, and precipitates Li_2CO_3 with saturated Na_2CO_3 solution at 90°C .

10.2 Recovery of anode materials

The recovery process of anode materials is relatively simple. After the separation of anode plates, the purity of copper can be more than 99%, which can be used for further refining electrolytic copper.

10.3 Recovery of diaphragm

The diaphragm material is mainly harmless, and has no recycling value.

10.4 List of recycling equipment:

Automatic dismantling machine, pulverizes, wet gold pool, etc.

11. Transportation Requirements

The battery products should be transported after packaging and during the transportation process, severe vibration, impact, or extrusion should be prevented to prevent sun and rain. It can be transported using vehicles such as cars, trains, and ships.

Always check all applicable local, national, and international regulations before transporting a Lithium Iron Phosphate battery.

Transporting an end-of-life, damaged, or recalled battery may, in certain cases, be specially limited or prohibited.

The transport of the Li-Ion battery falls under hazard class UN3480, class 9. For transport over water, air and land, the battery falls within packaging group PI965 Section I.

Use Class 9 Miscellaneous Dangerous Goods and UN Identification labels for transportation of lithium-ion batteries which are assigned Class 9. Refer to relevant transportation documents.

Lithium batteries and lithium-ion cells are regulated in the U.S. in accordance with Part 49 of the Code of Federal Regulations, (49 CFR Sections 105-180) of the U.S. Hazardous Materials Regulations.



Figure 10-1: Class 9 Miscellaneous Dangerous Goods and UN Identification Label