

AC charging cable - EV-T2G3PC-1AC32A-5,0M6,0ESBK01 - 1627801

Please be informed that the data shown in this PDF Document is generated from our Online Catalog. Please find the complete data in the user's documentation. Our General Terms of Use for Downloads are valid (<http://phoenixcontact.com/download>)

CHARX connect, Mobile AC charging cable with vehicle charging connector and infrastructure charging plug, with protective caps, Housing color black-gray, for charging electric vehicles (EV) with alternating current (AC) via type 2 vehicle charging inlets, compatible with type 2 infrastructure charging sockets at charging stations for electromobility (EVSE), Type 2, IEC 62196-2, 32 A / 250 V (AC), C-Line, "PHOENIX CONTACT" logo, cable: 5 m, black, straight

Product Description

Mobile AC charging cable with Vehicle Connector and Infrastructure plug for charging electric vehicles (EV) with alternating current (AC), via type 2 Vehicle Inlets, compatible with type 2 Infrastructure Socket Outlets at charging stations for E-Mobility (EVSE)

Your advantages

- Consistent design of all Phoenix Contact Vehicle Connectors and Infrastructure Plugs
- Silver-plated surface of the power and signal contacts
- Developed and produced in accordance with the IATF 16949 automotive standard and ISO 9001
- Material data available in the IMDS (International Material Data System of the automotive industry)
- Convenient handling, thanks to the ergonomic handle and additional, rubber grip components
- Tested in accordance with selected tests of automotive standards LV124, LV214, LV215-2
- Tested in accordance with EV Ready 37 requirements
- Laser-marked pin connector pattern in accordance with DIN EN 17186
- Consistent longitudinal water tightness prevents water ingress in the cable



Key Commercial Data

Packing unit	1 pc
GTIN	 4 055626 355283
GTIN	4055626355283
Weight per Piece (excluding packing)	2,321.000 g
Custom tariff number	85444290
Country of origin	Germany
Sales Key	XWBAEC

Technical data

Product definition

AC charging cable - EV-T2G3PC-1AC32A-5,0M6,0ESBK01 - 1627801

Technical data

Product definition

Type	Mobile AC charging cable
	with vehicle charging connector and infrastructure charging plug
	with protective caps
	Housing color black-gray
Application	for charging electric vehicles (EV) with alternating current (AC) via type 2 vehicle charging inlets
	compatible with type 2 infrastructure charging sockets at charging stations for electromobility (EVSE)
Affixed logo	"PHOENIX CONTACT" logo
Design	C-Line
Standards/regulations	IEC 62196-2
Charging standard	Type 2
Charging mode	Mode 3, Case B

Dimensions

Height	137 mm (Vehicle charging connector)
	131.8 mm (Infrastructure charging plug)
Width	70 mm (Vehicle charging connector)
	58 mm (Infrastructure charging plug)
Depth	215.9 mm (Vehicle charging connector)
	233.4 mm (Infrastructure charging plug)
Conductor length	5 m

Ambient conditions

Ambient temperature (operation)	-30 °C ... 50 °C
Ambient temperature (storage/transport)	-40 °C ... 80 °C
Max. altitude	5000 m (above sea level)
Degree of protection	IP44 (plugged in; when plugged in and ready to operate, the degree of protection is only ensued if both plug-in components are original products from Phoenix Contact or suitable standard-compliant products)
	IP54 (Protective cap)

Electrical properties

Charging power (nominal operation)	8 kW
Number of phases	1
Number of power contacts	3 (L1, N, PE)
Rated current of power contacts	32 A
Rated voltage for power contacts	250 V AC
Number of signal contacts	2 (CP, PP)
Rated current for signal contacts	2 A
Rated voltage for signal contacts	30 V AC
Type of signal transmission	Pulse width modulation
Note on the connection method	Crimp connection, cannot be disconnected
Resistor coding	220 Ω (between PE and PP)

AC charging cable - EV-T2G3PC-1AC32A-5,0M6,0ESBK01 - 1627801

Technical data

Mechanical properties

Insertion/withdrawal cycles	> 10000
Insertion force	< 100 N
Withdrawal force	< 100 N

Design

Design line	C-Line
Housing color	black
Mating face color	black
Color handle area	gray
Color protective cap	black
Customer variations	On request

Material

Housing material	Plastic
Material handle area	Soft plastic
Material protective cap	Soft plastic
Material mating face	Plastic
Flammability rating	V0
Material surface of contacts	Ag

Cable

Cable structure	3 x 6.0 mm ² + 1 x 0.5 mm ²
Wiring standards/regulations	prEN 50620 / DIN EN 50620
Wiring class	Class 5
Wiring certifications	VDE
External cable diameter	12.8 mm ±0.4 mm
Type of conductor	straight
Cable resistance	≤ 0.0033 Ω/m (based on a power core, at an ambient temperature of 20°C)
Outer sheath, material	TPE-U
External sheath, color	black
Minimum bending radius	96 mm (7.5 x diameter)
Cable weight	max. 305 kg/km

Environmental Product Compliance

REACH SVHC	Lead 7439-92-1
China RoHS	Environmentally Friendly Use Period = 10;
	For details about hazardous substances go to tab "Downloads", Category "Manufacturer's declaration"

Drawings

AC charging cable - EV-T2G3PC-1AC32A-5,0M6,0ESBK01 - 1627801

Connection diagram

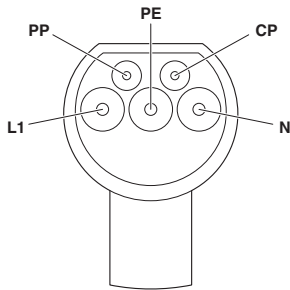

Dimensional drawing

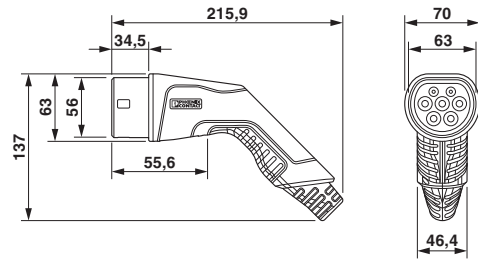

Pin assignment of Infrastructure Plug

Vehicle connector

Dimensional drawing

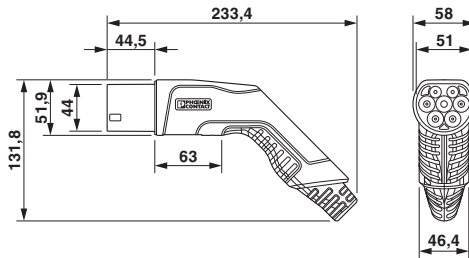

Infrastructure plug

AC charging cable - EV-T2G3PC-1AC32A-5,0M6,0ESBK01 - 1627801

Schematic diagram

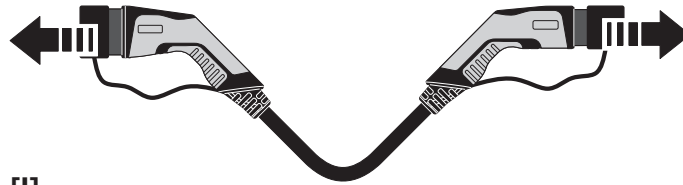

[I]

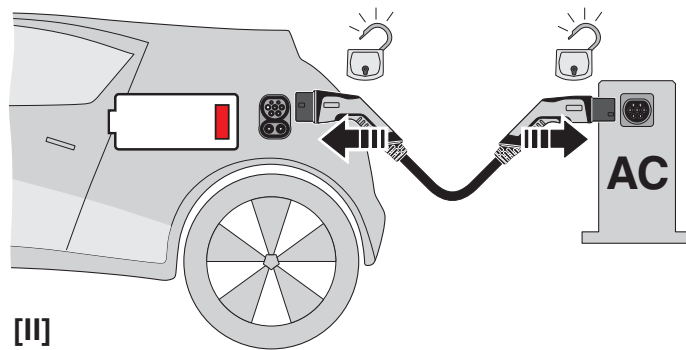

[II]

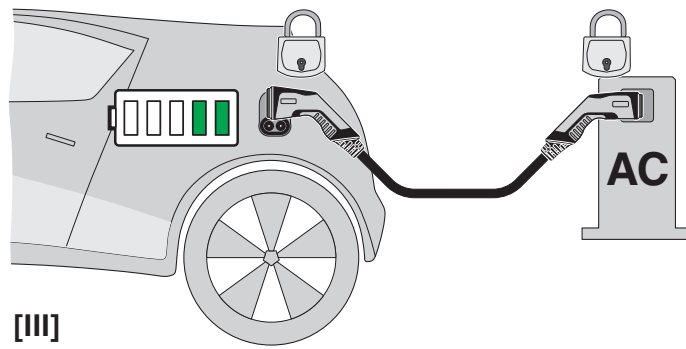

[III]

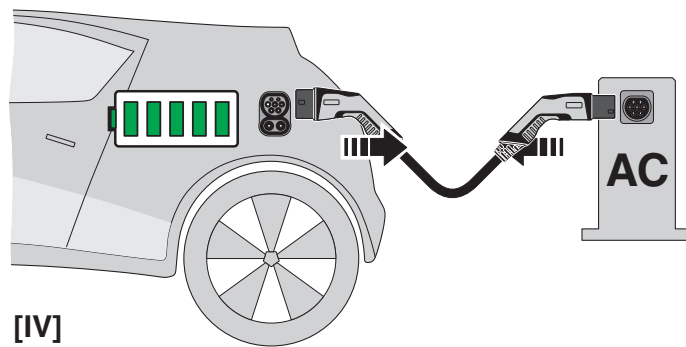

[IV]



[V]

AC charging cable - EV-T2G3PC-1AC32A-5,0M6,0ESBK01 - 1627801

Schematic diagram

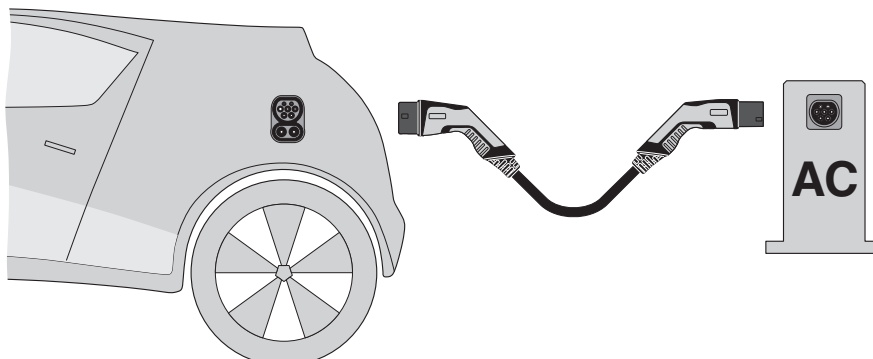

Terminology definition

Schematic diagram

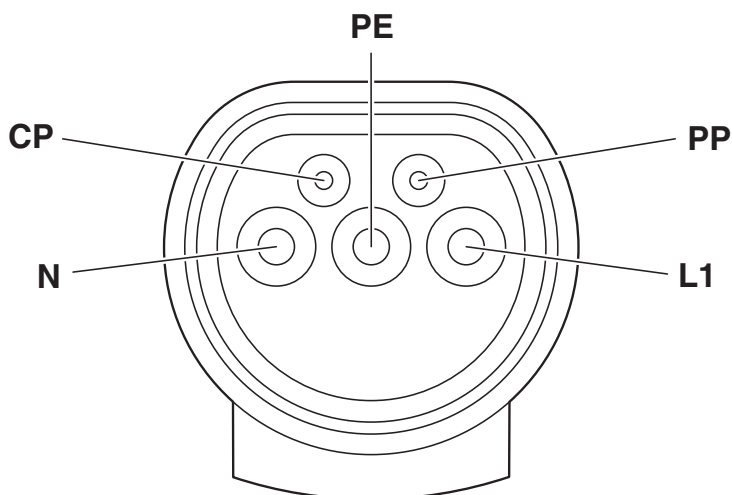

Pin assignment of the Vehicle Connector

Classifications

eCl@ss

eCl@ss 10.0.1	27144705
eCl@ss 11.0	27144705
eCl@ss 4.0	27140800
eCl@ss 4.1	27140800
eCl@ss 5.0	27143400
eCl@ss 5.1	27143400
eCl@ss 6.0	27143400
eCl@ss 7.0	27449001
eCl@ss 9.0	27144705

AC charging cable - EV-T2G3PC-1AC32A-5,0M6,0ESBK01 - 1627801

Classifications

ETIM

ETIM 3.0	EC002061
ETIM 4.0	EC002061
ETIM 6.0	EC002897
ETIM 7.0	EC002897

UNSPSC

UNSPSC 6.01	30211923
UNSPSC 7.0901	39121522
UNSPSC 11	39121522
UNSPSC 12.01	39121522
UNSPSC 13.2	39121522
UNSPSC 18.0	39121522
UNSPSC 19.0	39121522
UNSPSC 20.0	39121522
UNSPSC 21.0	39121522

Approvals

Approvals

Approvals

IECEE CB Scheme / VDE Zeichengenehmigung

Ex Approvals

Approval details

IECEE CB Scheme		http://www.iecee.org/	DE1-62390
Nominal voltage UN	250 V		
Nominal current IN	32 A		

VDE Zeichengenehmigung		http://www2.vde.com/de/Institut/Online-Service/VDE-gepruefteProdukte/Seiten/Online-Suche.aspx	40045394
Nominal voltage UN	250 V		
Nominal current IN	32 A		

AC charging cable - EV-T2G3PC-1AC32A-5,0M6,0ESBK01 - 1627801

Accessories

Accessories

Adhesive label

Label - EV-LABEL-C - 1309766



CHARX connect, Label, accordance to DIN EN 17186, for AC charging cable, Marking C for AC type 2 vehicle charging connectors and type 2 vehicle charging inlets

Label - EV-LABEL-C-SO - 1315521



CHARX connect, Label, accordance to DIN EN 17186, for AC charging cables and infrastructure charging sockets, Marking C for AC type 2 infrastructure charging plugs and type 2 infrastructure charging sockets

Charging connector holder

Charging connector holder - EV-T2AC-PARK - 1624148



CHARX connect, Charging connector holder, for vehicle charging connectors on charging stations (EVSE), Type 2, IEC 62196-2, Front mounting

Infrastructure socket outlet

Set - EV-T2M3SO12-3P-P-SET - 1164422



CHARX connect, Set, Combination of infrastructure charging socket, protective cover, and rear protective cap for strain relief and touch protection, rear protective cover screw connection, with temperature sensors, with LED status indicator within the protective cover, can be reconnected, For charging electric vehicles (EV) with alternating current (AC), Compatible with infrastructure charging plugs, Type 2, IEC 62196-2, 32 A / 480 V (AC), without cable, Locking actuator: 12 V, 3-position, Rear panel mounting, M5 thread, Generation 2 Premium, "PHOENIX CONTACT" logo

Set - EV-T2M3SO12-4P-P-SET - 1164423



CHARX connect, Set, Combination of infrastructure charging socket, protective cover, and rear protective cap for strain relief and touch protection, rear protective cover screw connection, with temperature sensors, with LED status indicator within the protective cover, can be reconnected, For charging electric vehicles (EV) with alternating current (AC), Compatible with infrastructure charging plugs, Type 2, IEC 62196-2, 32 A / 480 V (AC), without cable, Locking actuator: 12 V, 4-position, Rear panel mounting, M5 thread, Generation 2 Premium, "PHOENIX CONTACT" logo

AC charging cable - EV-T2G3PC-1AC32A-5,0M6,0ESBK01 - 1627801

Accessories

Set - EV-T2M3SO12-3P-BL-SET - 1268358



CHARX connect, Set, Combination of infrastructure charging socket, protective cover, and rear protective cap for strain relief and touch protection, rear protective cover screw connection, with LED status indicator within the protective cover, can be reconnected, For charging electric vehicles (EV) with alternating current (AC), Compatible with infrastructure charging plugs, Type 2, IEC 62196-2, 32 A / 480 V (AC), without cable, Locking actuator: 12 V, 3-position, Rear panel mounting, M5 thread, Generation 2 Basic with LED cover, "PHOENIX CONTACT" logo

Set - EV-T2M3SO12-4P-BL-SET - 1268355



CHARX connect, Set, Combination of infrastructure charging socket, protective cover, and rear protective cap for strain relief and touch protection, rear protective cover screw connection, with LED status indicator within the protective cover, can be reconnected, For charging electric vehicles (EV) with alternating current (AC), Compatible with infrastructure charging plugs, Type 2, IEC 62196-2, 32 A / 480 V (AC), without cable, Locking actuator: 12 V, 4-position, Rear panel mounting, M5 thread, Generation 2 Basic with LED cover, "PHOENIX CONTACT" logo

Set - EV-T2M3SO12-3P-B-SET - 1164420



CHARX connect, Set, Combination of infrastructure charging socket, protective cover, and rear protective cap for strain relief and touch protection, rear protective cover screw connection, can be reconnected, For charging electric vehicles (EV) with alternating current (AC), Compatible with infrastructure charging plugs, Type 2, IEC 62196-2, 32 A / 480 V (AC), without cable, Locking actuator: 12 V, 3-position, Rear panel mounting, M5 thread, Generation 2 Basic, "PHOENIX CONTACT" logo

Set - EV-T2M3SO12-4P-B-SET - 1164417



CHARX connect, Set, Combination of infrastructure charging socket, protective cover, and rear protective cap for strain relief and touch protection, rear protective cover screw connection, can be reconnected, For charging electric vehicles (EV) with alternating current (AC), Compatible with infrastructure charging plugs, Type 2, IEC 62196-2, 32 A / 480 V (AC), without cable, Locking actuator: 12 V, 4-position, Rear panel mounting, M5 thread, Generation 2 Basic, "PHOENIX CONTACT" logo